

## Series Spec Sheet

# VT4-L GEN 2

## 4' LED VAPOR TIGHT With Made To Order Options Optional Emergency Remote

A vandal resistant luminaire with superior light distribution, the VT4-L is ideal for a variety of indoor/outdoor industrial, commercial and residential applications. Intended for environments where moisture and/or dust may be present.

### FEATURES AND SPECIFICATIONS

#### • Applications<sup>1</sup>

- Parking garages
- Subways
- Schools
- Industrial facilities
- Exterior retail areas
- Storage rooms
- Garden centers
- Airports

#### • Construction

##### Housing

- Lightweight, flexible and durable polycarbonate construction makes the luminaire vandal resistant and highly impact resistant
- The housing is sealed with a uniform gasket that blocks the ingress of moisture and dust
- Reinforced polycarbonate latches lock the luminaire together
- Row mount aligners molded into housing ends
- Sealed strain relief/cable gland kit included
- Power connection is easily accomplished through pre-drilled hole on one end of the housing. Wet location gland is included to seal the fixture from moisture

##### Lens

The UV stabilized polycarbonate lens with LED diffusing pigment is impervious to rust or rot and is unaffected by extreme temperatures

#### • Specifications

- Easy to clean and service
- LED technology for long term energy savings

##### Driver

- 120 V, 120-277 V and 347 V
- 0-10V dimming driver. Dimming cables sold separately, see ordering guide (S1-S4 goes down to 1%)
- Protection against short circuit and open circuit, inrush current complies with NEMA 410, transient protector complies with IEEE C62.41, 2.5 kV/2.5 kV

##### Operating temperature

-40°C to +40°C (-40°F to 104°F)  
DL: 0°C to +25°C (32° to 77°F)

LINK: -40°C to +40°C (-40°F to 104°F)

##### Mounting

Stainless steel mounting hardware for wall, ceiling or suspended mounting.

#### • Optional Emergency Lighting

##### LINK Normally ON LED Vapor Tight Luminaire

- Consuming 11 W, 12 - 24 VDC
- 200 mA constant current
- Delivers 1 218 to 1 409 lumens in emergency mode
- Ease of maintenance when used with Stanpro emergency lighting battery units complete with auto test function
- Complements Stanpro's Normally ON LED Vapor Tight family
- Patent Pending

*Please view the LINK specification section for more details on this technology*

#### • Emergency Lighting Compliances

- Complies to CSA C22.2 #141-15 (When use with DL, EL option)
- Meets ICES-005 requirements

#### • Compliances

- Suitable for damp and wet locations
- IP65
- 1 500 PSI: High pressure hose down test (1.3 gallon per minute for 3 minutes at 1.5-2.0' from the unit) to maintain the integrity of the fixture. No water ingress is allowed
- Meets requirements of ICES-005 for class A products
- cETL
- DLC Premium, DLC Standard
- BC Hydro



### OVERVIEW

Light source	LED
Watts (W)	24 - 51
Lumen output (lm)	3 376 - 7 748
Efficacy (lm/W)	129 - 156
Color temperature (K)	3 000, 3 500, 4 000, 5 000
CRI	80+ , 90+
Weight (lbs)	8.45

<sup>1</sup> Not recommended for car wash applications.

<sup>1</sup> 5 year warranty for the LINK module.

Not all products are qualified on the DLC QPL. To view our DLC qualified products, please consult the DLC Qualified Products List at [www.designlights.org/search](http://www.designlights.org/search).

**ORDERING GUIDE**

Series	Lamp type	Lumen package	CRI	Volts (V)	Color temp. (K)	Options
VT4	L - LED	S1B - S2B - S3B - S4B -	80 - 80+ 90 <sup>7</sup> - 90+	A - 120 H - 347 W - 120-277	30K - 3 000 35K - 3 500 40K - 4 000 50K - 5 000	DIM1 <sup>1</sup> - 5 wire cable for AC and 0-10 V dimming DIM2 <sup>2</sup> - Line voltage dimming driver 120 V L6 - 6' white power cable length L10 - 10' white power cable length L6-BK - 6' black power cable length L10-BK - 10' black power cable length SS - Stainless steel latches (set of 10pcs) OS <sup>3</sup> - Occupancy sensor DL <sup>4,11</sup> - AC and Emergency backup (from 0°C - 25°C) 120 V, 120-277 V EL <sup>5,10</sup> - LINK Normally ON Emergency Remote TP <sup>6</sup> - Vandal Resistant Kit (includes 6pcs tamper proof screws) KV - 10kV Surge protector RMB-05 <sup>8</sup> - Rigid mono point on bracket with 3/4" center hole for 1/2 NPT conduit RMB-075 <sup>8</sup> - Rigid mono point on bracket with 1" center hole for 3/4 NPT conduit RMP-05 <sup>8,11</sup> - Rigid mono point on the luminaire with 3/4" center hole for 1/2 NPT conduit RMP-075 <sup>8,11</sup> - Rigid mono point on the luminaire with 1" center hole for 3/4 NPT conduit PVPM-05 <sup>8</sup> - Rigid mono point on pivot mount bracket with 3/4" center hole and 1/2 NPT PVPM-075 <sup>8</sup> - Rigid mono point on pivot mount bracket with 1" center hole and 3/4 NPT PVM <sup>8</sup> - Surface mount brackets with pivot (set of 2) EH - Additional 7/8" end hole with wet location gland CH - 7/8" center hole with wet location gland AC <sup>9</sup> - Aviation cable

<sup>1</sup> DIM1 option must select L6, L10, L6-BK or L10-BK. DL option is not compatible with DIM1.  
<sup>2</sup> DIM2 only for S1B, S2B and S3B lumen packages  
<sup>3</sup> To see available options, please consult the occupancy sensors section  
<sup>4</sup> Fixture functional in AC mode, when power goes off emergency bodine (DL) powers LED boards. One bodine per fixture is standard unless otherwise specified  
<sup>5</sup> Contact factory for availability  
<sup>6</sup> 1 tamper proof bit (HAR06-TPBIT-UDR) included per order. Please consult the accessory table to order additional quantities  
<sup>7</sup> 90 CRI option may decrease lumen output from 15% to 19% depending on the CCT  
<sup>8</sup> See Mounting Options table  
<sup>9</sup> Aviation cable length based on selected power cable length  
<sup>10</sup> The LINK Emergency Power conversion module is compatible with all the following all configurations: LS1B, LS2B, LS3B, LS4B. Not compatible with the following options: DL, EH, OS (external), RMP-05, RMP-075. When in Emergency Mode, luminaire only consumes 11W  
<sup>11</sup> When selecting DL, RMP-05 and RMP-075 options, the fixture maintains wet location status, however IP rating is no longer applicable  
**For Emergency Lighting spacing, please see p.5**

**TECHNICAL SPECIFICATION TABLE**

Lumen package	Watts (W)	Volts (V)	3 000 K		3 500 K		4 000 K		5 000 K		CRI	Life L70 (hrs)	Tested hours LM-80 (hrs)	Power factor	THD (%)
			Lumen (lm)	Efficacy (lm/W)	Lumen (lm)	Efficacy (lm/W)	Lumen (lm)	Efficacy (lm/W)	Lumen (lm)	Efficacy (lm/W)					
S1B	24	120-277 347	3 376	129	3 487	133	3 568	136	3 626	138	80+	190 400	9 000	0.932	16.2
S2B	28		4 244	139	4 384	143	4 486	147	4 558	149				0.951	14.3
S3B	33		4 747	145	4 903	150	5 017	153	5 098	156				0.959	13.6
S4B	51		7 215	140	7 453	144	7 626	148	7 748	150				0.948	9.7

**LINK TECHNICAL SPECIFICATION TABLE**

Lumen package	Luminaire Watts (W)	LINK Watts (W)	3 000 K	3 500 K	4 000 K	5 000 K
			LINK lumen output (lm)	LINK lumen output (lm)	LINK lumen output (lm)	LINK lumen output (lm)
LS1B	26	11	1 312	1 355	1 387	1 409
LS2B	31					
LS3B	33					
LS4B	52					

**ACCESSORIES (order separately)**

Product number	Type
HAR06-TPBIT-UDR	Tamper Proof 2" Steel Power Bit

Data is based upon tests performed in a controlled environment. Actual performance can vary depending on operating conditions. All products are subject to change or may be discontinued any time without notice.

**DIMENSIONS**

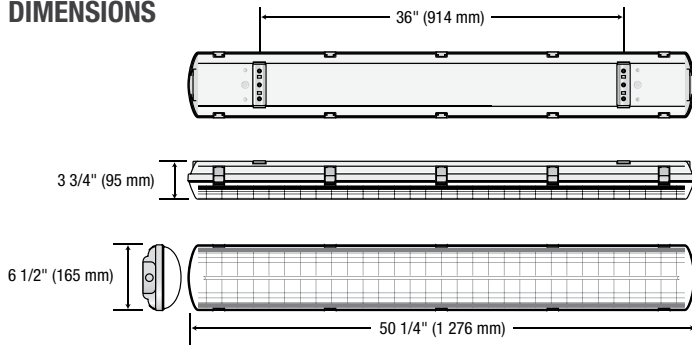

**MOUNTING TYPE**

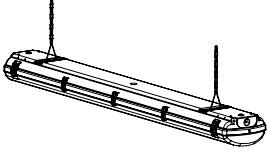
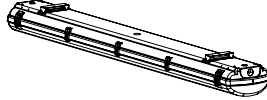
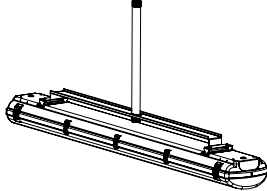
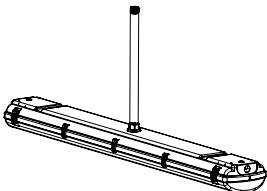
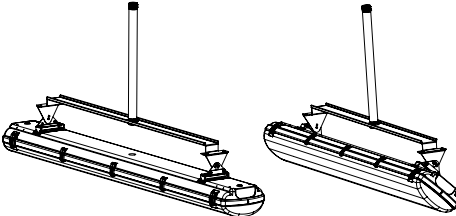
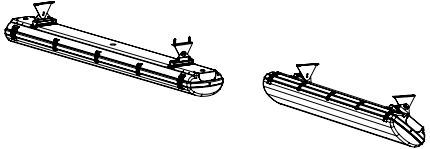
<p><b>SUSPENDED</b></p>	<ul style="list-style-type: none"> <li>– Set of 2 v-hooks for suspended mounting, included with the luminaire</li> <li>– Aviation cable purchased separately, see ordering guide</li> </ul>	
<p><b>SURFACE</b></p>	<ul style="list-style-type: none"> <li>– Stainless steel surface mounting hardware for ceiling / wall, included with the luminaire</li> </ul>	
<p><b>RMB-05</b> Rigid mono point on bracket with 3/4" center hole and 1/2 NPT</p>	<ul style="list-style-type: none"> <li>– To be used in conjunction with the surface mounting hardware, included with the luminaire</li> <li>– For other center hole dimensions, select CH option in the ordering guide</li> </ul>	
<p><b>RMB-075</b> Rigid mono point on bracket with 1" center hole and 3/4 NPT</p>		
<p><b>RMP-05</b> Rigid mono point with 3/4" center hole and 1/2 NPT</p>	<ul style="list-style-type: none"> <li>– Rigid mono point directly on the luminaire with waterproof hub</li> <li>– Conduit not provided</li> </ul>	
<p><b>RMP-075</b> Rigid mono point on bracket with 1" center hole and 3/4 NPT</p>		
<p><b>PVPM-05</b> Rigid mono point on pivot mount bracket with 3/4" center hole and 1/2 NPT</p>	<ul style="list-style-type: none"> <li>– To be used in conjunction with the surface mounting hardware, included with the luminaire</li> <li>– For 7/8" center hole, consult CH option on the ordering guide</li> <li>– Conduit not provided</li> </ul>	
<p><b>PVPM-075</b> Rigid mono point on pivot mount bracket with 1" center hole and 3/4 NPT</p>		
<p><b>PVM</b> Surface mount brackets with pivot (set of 2)</p>	<ul style="list-style-type: none"> <li>– To be used in conjunction with the surface mounting hardware, included with the luminaire</li> <li>– For ceiling / wall surface mounting</li> </ul>	

Data is based upon tests performed in a controlled environment. Actual performance can vary depending on operating conditions. All products are subject to change or may be discontinued any time without notice.

## OCCUPANCY SENSORS

### ON-OFF SENSORS

Detection - On at (Detection Area) % during (Hold Time) min. Off

Part number	Position	Volts (V)	Technology	Height (ft)	Detection Area (%)	Hold time (min)	Daylight min level (lux)	Remote <sup>1</sup>	Location <sup>2</sup> (°C)
OSE-PO-0301	External	120-347	PIR	20-40	100	20	N/A	N/A	Dry, -10 to +40
OSE-PO-0302	External	120-347	PIR	20-40	100	20	N/A	N/A	Dry, -40 to +40
OSE-PO-0501	External	120-347	PIR	15-40	100	15	3 000	OSI-FSIR-100	Dry, 0 to +40
OSE-PO-0502	External	120-347	PIR	15-40	100	15	3 000	N/A	Dry, 0 to +40
OSE-PO-0701	External	120-277	PIR	20	100	15	N/A	N/A	Wet, -40 to +40
OSI-FO-0301	Internal	120-277	High Frequency	32 max	100	20	Disable	N/A	Dry and wet, -25 to +40
OSI-FO-0601	Internal	120-347	High Frequency	25 max	100	30	Disable	68681	Dry and wet, -35 to +40
OSI-FO-0602	Internal	120-347	High Frequency	25 max	100	15	Disable	68681	Dry and wet, -35 to +40
OSI-FO-0603	Internal	120-347	High Frequency	25 max	100	15	100	68681	Dry and wet, -35 to +40

### BI-LEVEL SENSORS

Detection - On at (Detection Area) % during (Hold Time) min., then (Stand-by Dim level) %

Part number	Position	Volts (V)	Technology	Height (ft)	Detection Area (%)	Hold time (min)	Stand-by Dim level (%)	Daylight min level (lux)	Remote <sup>1</sup>	Location <sup>2</sup> (°C)
OSE-PB-0202	External	120-347	PIR	20	100	30	40	Disable	OSI-FSIR-100	Wet, -40 to +40
OSI-FB-0301	Internal	120-277	High Frequency	32 max	100	20	30	Disable	N/A	Dry and wet, -25 to +40
OSI-FB-0302	Internal	120-277	High Frequency	32 max	100	20	10	Disable	N/A	Dry and wet, -25 to +40
OSI-FB-0303	Internal	120-277	High Frequency	32 max	100	20	50	Disable	N/A	Dry and wet, -25 to +40
OSE-FB-0402	External	120-347	High Frequency	50 max	100	20	30	50	OSI-RC-MH10	Wet, -35 to +40
OSI-FB-0603	Internal	120-347	High Frequency	25 max	100	15	40	Disable	68681	Dry and wet, -35 to +40
OSI-FB-0604	Internal	120-347	High Frequency	25 max	100	30	40	Disable	68681	Dry and wet, -35 to +40
OSI-FB-0605	Internal	120-347	High Frequency	25 max	100	15	30	Disable	68681	Dry and wet, -35 to +40
OSI-FB-0606	Internal	120-347	High Frequency	25 max	100	15	10	Disable	68681	Dry and wet, -35 to +40

### TRI-LEVEL SENSORS

Detection - On at (Detection Area) % during (Hold Time) min., then (Stand-by Dim level) % during (Stand-by period) min. Off

Part number	Position	Volts (V)	Technology	Height (ft)	Detection Area (%)	Hold time (min)	Stand-by Dim level (%)	Stand-by period (min)	Daylight min level (lux)	Remote <sup>1</sup>	Location <sup>2</sup> (°C)
OSI-FT-0301	Internal	120-277	High Frequency	32 max	100	20	30	10	Disable	N/A	Dry and wet, -25 to +40
OSE-FT-0402	External	120-347	High Frequency	50 max	100	30	30	10	50	OSI-RC-MH10	Wet, -35 to +40
OSI-FT-0601	Internal	120-347	High Frequency	25 max	100	30	30	10	Disable	68681	Dry and wet, -35 to +40

<sup>1</sup> To be ordered separately.

<sup>2</sup> Min and max ambient temperature of the fixture with the specific sensor. Please verify fixture temperature on the first page for compatibility with sensor.

For more settings visit  
[www.standardpro.com/documentation/technical-information/](http://www.standardpro.com/documentation/technical-information/)

Data is based upon tests performed in a controlled environment. Actual performance can vary depending on operating conditions.  
 All products are subject to change or may be discontinued any time without notice.

# LINK

## NORMALLY ON EMERGENCY REMOTE LUMINAIRE

This luminaire can be used with an emergency backup powered by either a 12 V or 24 V DC Stanpro battery unit, complete with or without auto test.

### NORMAL MODE



### EMERGENCY MODE

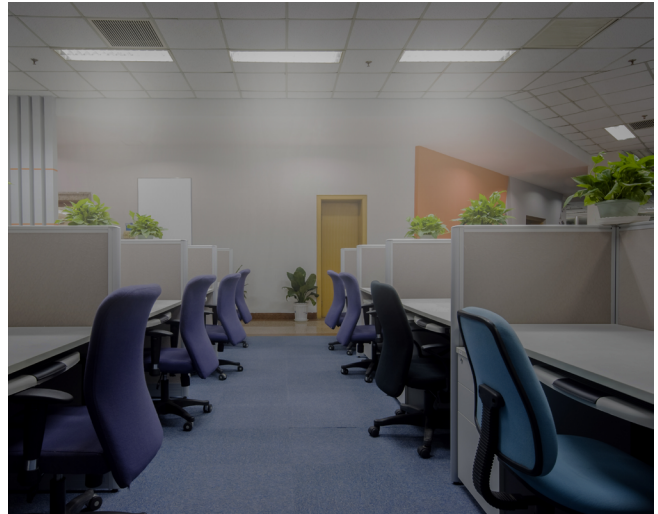

### TYPICAL SPECIFICATION

Supply and install Stanpro LINK \_\_\_\_\_ ft, LED vapor tight, Model number: \_\_\_\_\_ remote normally ON emergency luminaire, CSA C22.2 141-15 certified and meet the requirements prescribed by ICES-005. Normally ON when AC is present and when connected to a Stanpro battery unit complete with or without auto test, the luminaire shall act as an emergency lighting remote and consume 11 W of DC power in \_\_\_\_\_ V producing 2 924 - 3 146 lumens in emergency mode.

The remote normally ON emergency luminaire shall be powered by a Stanpro emergency lighting battery unit as described herein and shown on the drawings. The Stanpro auto diagnostic micro-controller board shall supply the rated load for a minimum of a 1/2 hour to 87.5% of the rated battery voltage. The unit shall be rated 120 V, 277 V or 347 V, 60 Hz and be CSA listed. The unit shall have an output of: \_\_\_V and \_\_\_W. The charge voltage factory set to  $\pm 1\%$  tolerance. High efficiency, rapid recovery, precision control charging system shall be employed to promote long battery life and reduce the potential for grid corrosion. The charger shall provide a continuous high charge to recharge the battery, when the battery is at full capacity, the charger will shut-off. Periodically the charger shall provide a pulse of energy to keep the battery topped off. The pulse charger shall be precisely regulated and shall charge the battery in relation to its temperature, state or charge and input voltage fluctuations. The charger shall be current limited, temperature compensated, short-circuit proof and reverse polarity protected. The unit shall be furnished with an electronic lockout circuit, which will connect the battery when the AC circuit is activated, and an electronic brownout circuit, which will activate the emergency lights when utility power dips below 75% of nominal voltage. A low voltage battery protection circuit shall be provided and will disconnect the load when the battery reaches the end of discharge.

The automated testing performed by the Stanpro auto test system has been designed to comply with all of the requirements of the National Fire Code. Every month, a 5 minute discharge and diagnostic test checks the operational status of the unit. Every 12 months, this test is extended to the full 30 minute, code required duration. This ensures that the battery charger is recharging the battery in accordance with code requirements.

The unit shall be Stanpro model: SL\_ \_\_\_\_\_

Data is based upon tests performed in a controlled environment. Actual performance can vary depending on operating conditions. All products are subject to change or may be discontinued any time without notice.

# LINK

## NORMALLY ON EMERGENCY REMOTE LUMINAIRE

### LINK Wiring Diagram

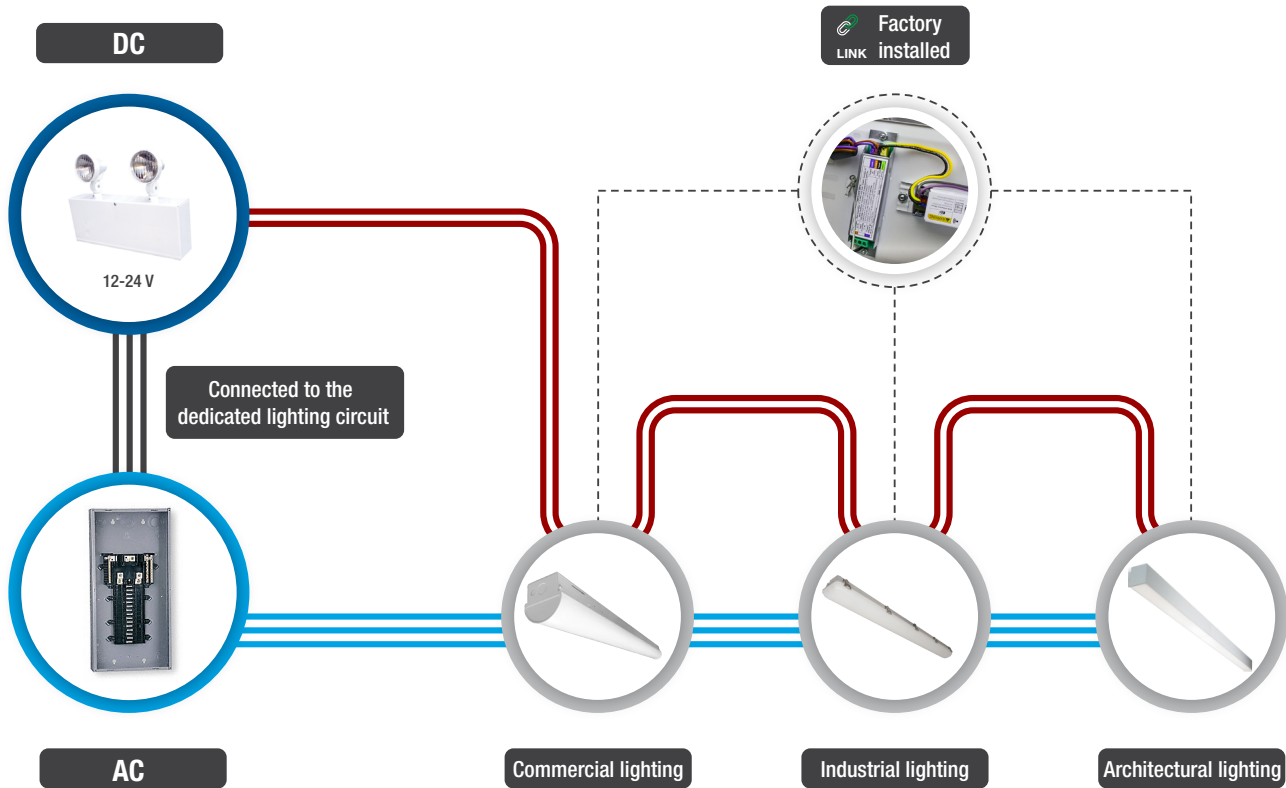

**LEGEND**

- AC wires
- Connected to the dedicated lighting circuit
- DC wires
- LINK factory installed

Emergency mode	Spacing
VT4-L GEN 2	Average spacing for 1 out of every 4 luminaires, normally ON in the path of egress, when at 8, 10, or 12 foot mounting heights.

Data is based upon tests performed in a controlled environment. Actual performance can vary depending on operating conditions. All products are subject to change or may be discontinued any time without notice.

**PHOTOMETRIC DATA<sup>1</sup>**

**VT4-LS1B-80-(A/H/W)/40K • 3 567 lm**

**Polar candela distribution**

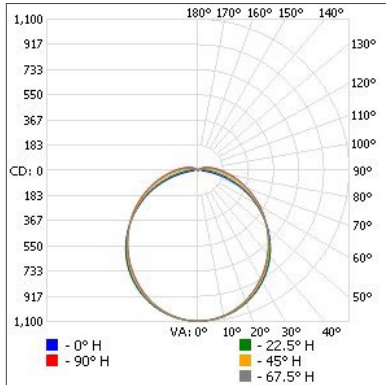

**Zonal lumen summary**

Zone	Lumens	% Fixture
0-30	848.5	23.8
0-40	1 389.5	39
0-60	2 475.4	69.4
60-90	885.9	24.8
70-100	561.0	15.7
90-120	181.6	5.1
0-90	3 361.3	94.2
90-180	205.9	5.8
0-180	3 567.3	100

**Illuminance at a distance**

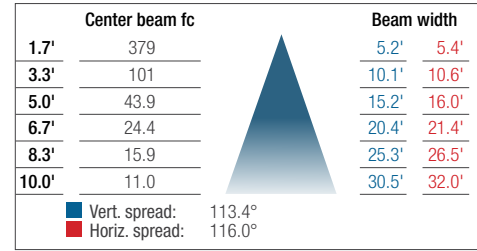

**VT4-LS2B-80-(A/H/W)/40K • 4 485 lm**

**Polar candela distribution**

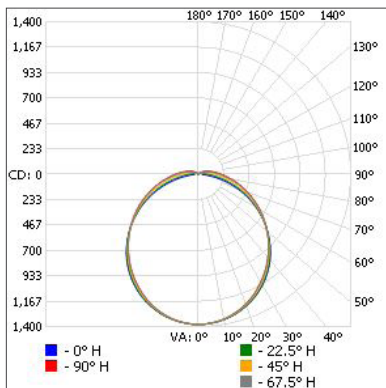

**Zonal lumen summary**

Zone	Lumens	% Fixture
0-30	1 066.8	23.8
0-40	1 747.0	39
0-60	3 112.3	69.4
60-90	1 113.8	24.8
70-100	705.3	15.7
90-120	228.3	5.1
0-90	4 226.2	94.2
90-180	258.9	5.8
0-180	4 485.1	100

**Illuminance at a distance**

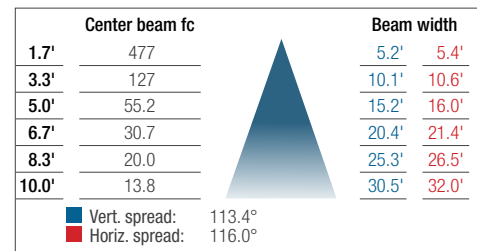

**VT4-LS3B-80-(A/H/W)/40K • 5 016 lm**

**Polar candela distribution**

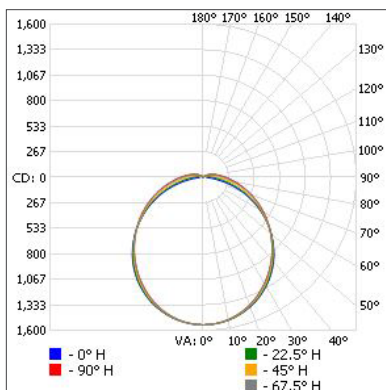

**Zonal lumen summary**

Zone	Lumens	% Fixture
0-30	1 193.1	23.8
0-40	1 953.8	39
0-60	3 480.8	69.4
60-90	1 245.7	24.8
70-100	788.8	15.7
90-120	255.4	5.1
0-90	4 726.4	94.2
90-180	289.5	5.8
0-180	5 015.9	100

**Illuminance at a distance**

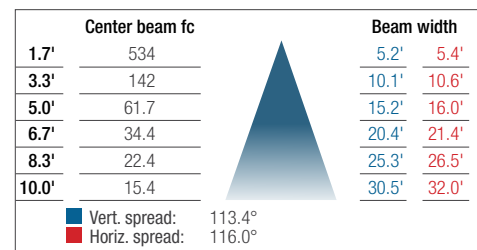

<sup>1</sup> Complete IES files available on our website.

Data is based upon tests performed in a controlled environment. Actual performance can vary depending on operating conditions. All products are subject to change or may be discontinued any time without notice.

**PHOTOMETRIC DATA<sup>1</sup>**

**VT4-LS4B-80-(A/H/W)/40K • 7 625 lm**

**Polar candela distribution**

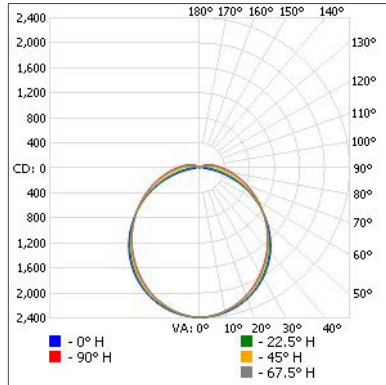

**Zonal lumen summary**

Zone	Lumens	% Fixture
0-30	1 831.4	24
0-40	2 990.3	39.2
0-60	5 296.7	69.5
60-90	1 871.1	24.5
70-100	1 194.9	15.7
90-120	402.3	5.3
0-90	7 167.7	94
90-180	457.3	6
0-180	7 625.0	100

**Illuminance at a distance**

	Center beam fc	Beam width	
1.7'	827	5.1'	5.1'
3.3'	220	9.9'	10.0'
5.0'	95.6	15.0'	15.1'
6.7'	53.3	20.0'	20.2'
8.3'	34.7	24.8'	25.1'
10.0'	23.9	29.9'	30.2'

■ Vert. spread: 112.5°  
■ Horiz. spread: 113.0°

<sup>1</sup> Complete IES files available on our website.

Data is based upon tests performed in a controlled environment. Actual performance can vary depending on operating conditions. All products are subject to change or may be discontinued any time without notice.