

## Series Spec Sheet

# VT2-L GEN 2

## 2' LED VAPOR TIGHT With Made To Order Options Optional Emergency Remote

A luminaire ideal for a variety of indoor/outdoor industrial and commercial applications. Intended for environments where moisture and/or dust may be present. Ideal for garages and stairwell.

### FEATURES AND SPECIFICATIONS

#### • Applications<sup>1</sup>

- Industrial facilities
- Stairwells
- Parking garages
- Exterior retail areas
- Transportation
- Pedestrian tunnels

#### • Construction

##### Housing

- Lightweight, flexible, durable and sealed polycarbonate construction
- Integral gasket forms uniform, long-life seal around the entire enclosure
- Reinforced polycarbonate latches
- Sealed strain relief/cable gland kit included
- Power connection is easily accomplished through pre-drilled hole on one end of the housing. Wet location gland is included to seal the fixture from moisture.

##### Lens

The UV stabilized polycarbonate lens with LED diffusing pigment is impervious to rust or rot and is unaffected by extreme temperatures

#### • Specifications

- Easy to clean and service
- LED technology for long term energy savings

##### Driver

- 120 V, 120 V-277 V and 347 V
- 0-10V dimming driver (down to 1%). Dimming cables sold separately, see ordering guide
- 2.5 kV surge protection (standard). See options table for additional surge protection

##### Operating Temperature

-40°C to +40°C (-40°F to 104°F)  
DL: 0°C to +25°C (32° to 77°F)  
LINK: -40°C to +40°C (-40°F to 104°F)

##### Lens

- Stainless steel surface mounting hardware for wall/ceiling included with the luminaire
- Set of 2 V-hooks also included for suspended mounting. Consult ordering guide for more options

##### Mounting

Stainless steel surface mounting hardware for wall/ceiling included with the luminaire. Set of 2 v-hooks also included for suspended mounting. Consult ordering guide for more options.

#### • Optional Emergency Lighting

##### LINK Normally ON LED Vapor Tight Luminaire

- Consuming 11 W, 12-24 VDC
- 200 mA constant current
- Delivers 1 193 to 1 367 lumens in emergency mode
- Ease of maintenance when used with Stanpro emergency lighting battery units complete with auto test function
- Complements Stanpro's Normally ON LED Vapor Tight family
- Patent pending

Please view the LINK specification section for more details on this technology

#### • Emergency Lighting Compliances

- Complies to CSA C22.2 #141-15 (When use with DL, EL option)
- Meets ICES-005 requirements

#### • Compliances

- Suitable for damp & wet locations
- IP65
- 1 500 PSI: High pressure hose down test (1.3 gallon per minute for 3 minutes at 1.5-2.0' from the unit) to maintain the integrity of the fixture. No water ingress is allowed
- Meets requirements of ICES-005 for class A products
- cETL
- DLC Premium, DLC Standard
- BC Hydro



quick  
ship



LINK 1  
EMERGENCY  
LIGHTING  
LUMINAIRE  
remote normally ON



LED  
fixture



wet  
location



ICES  
005



<sup>1</sup> 5 year warranty for the LINK module. Not all products are qualified on the DLC QPL. To view our DLC qualified products, please consult the DLC Qualified Products List at [www.designlights.org/search](http://www.designlights.org/search).

### OVERVIEW

Light source	LED
Watts (W)	17 - 30
Lumen output (lm)	2 143 - 4 210
Efficacy (lm/W)	126 - 141
Color temperature (K)	3 000, 3 500, 4 000, 5 000
CRI	80+, 90+
Weight (lbs)	4.35

<sup>1</sup> Not recommended for car wash applications.

**QUICK SHIP AND TECHNICAL SPECIFICATION TABLE**  <sup>1</sup>

Part number	Model number	DL Premium Unique ID <sup>5</sup>	DLC Standard Unique ID <sup>6</sup>	Watts (W)	Volts (V AC)	Color temp. (K) <sup>2</sup>	Lumen output (lm) <sup>3</sup>	Efficacy (lm/W)	CRI	Life L70 (hrs) <sup>4</sup>	Tested hours LM-80 (hrs) <sup>4</sup>	Dimming (V)	Power factor	THD (%)
69430	VT2-LS1B-80-W/40K	S-KUS8TP	S-JWOBLH	17	120-277	4 000	2 265	133	80+	190 400	9 000	0-10	0.9	20

<sup>1</sup> **QUICK SHIP:** Product availability is subject to change without notice. Please contact your Stanpro customer service representative to confirm inventory levels at time of order.

<sup>2</sup> Typical color temperature range: +/- 5 %.

<sup>3</sup> Lumen values are derived from photometric testing. Initial lumens range: +/- 10 %.

<sup>4</sup> Life hours are derived from IESNA LM-80-08 testing report and projected per IESNA TM-21-11 extrapolations.

<sup>5</sup> Primary Use Designation: Stairwell and Passageway Luminaire.

<sup>6</sup> Primary Use Designation: Direct Linear Ambient Luminaires.

**ORDERING GUIDE**

Series	Lamp type	Lumen package (lm)	CRI	Volts (V)	Color temp. (K)	Options	
VT2	L - LED	S1B } Refer to the technical specification table for more details S2B }	80 - 80+ 90 <sup>11</sup> - 90+	A - 120 H - 347 W - 120-277	30K - 3 000 35K - 3 500 40K - 4 000 50K - 5 000	L6 - 6' power cable length L10 - 10' power cable length AC <sup>1</sup> - Aviation cable SS - Stainless steel latches (set of 10pcs) OS <sup>2</sup> - Occupancy sensor EL <sup>3,12</sup> - LINK Normally ON Emergency Remote DL <sup>4,13</sup> - AC and Emergency backup (from 0°C - 25°C) 120 V, 120-277 V DIM1 <sup>5</sup> - 0-10 V internal dimming wires ready to connect DIM2 <sup>6</sup> - Line voltage dimming driver 120 V KV - 10kV Surge protector TP <sup>7</sup> - Vandal Resistant Kit (includes 6pcs tamper proof screws) RMB-05 <sup>8</sup> - Rigid mono point on bracket with 3/4" center hole for 1/2 NPT conduit RMB-075 <sup>8</sup> - Rigid mono point on bracket with 1" center hole for 3/4 NPT conduit RMP-05 <sup>8,13</sup> - Rigid mono point on the luminaire with 3/4" center hole for 1/2 NPT conduit RMP-075 <sup>8,13</sup> - Rigid mono point on the luminaire with 1" center hole for 3/4 NPT conduit PVPM-05 <sup>8</sup> - Rigid mono point on pivot mount bracket with 3/4" center hole and 1/2 NPT PVPM-075 <sup>8</sup> - Rigid mono point on pivot mount bracket with 1" center hole and 3/4 NPT PVM <sup>8</sup> - Surface mount brackets with pivot (set of 2) EH <sup>9</sup> - Additional 7/8" end hole with wet location gland CH <sup>10</sup> - 7/8" center hole with wet location gland	

<sup>1</sup> Aviation cable length based on selected power cable length.

<sup>2</sup> To see available options, please consult the occupancy sensors section.

<sup>3</sup> Contact factory for availability.

<sup>4</sup> DL option is not compatible with OS (internal).

<sup>5</sup> DIM1 option must select L6 or L10. DL option is not compatible with DIM1.

<sup>6</sup> DIM2 option is not compatible with OS (internal).

<sup>7</sup> 1 tamper proof bit (HAR06-TPBIT-UDR) included per order. Please consult the accessory table to order additional quantities.

<sup>8</sup> See Mounting Options table.

<sup>9</sup> Luminaire includes 1 end hole with wet location gland for main power connection. The /EH option offers a second end hole with wet location gland on the opposite side of the luminaire.

<sup>10</sup> Use plug (included with the luminaire) to block End Hole, if not in use.

<sup>11</sup> 90 CRI option may decrease lumen output from 15% to 19% depending on CCT.

<sup>12</sup> The LINK Emergency Power conversion module is compatible with all the following all configurations: LS1B, LS2B. Not compatible with the following options: DL, EH, OS (external), RMP-05, RMP-075. When in Emergency Mode, luminaire only consumes 11W.

<sup>13</sup> When selecting DL, RMP-05 and RMP-075 options, the fixture maintains wet location status, however IP rating is no longer applicable.

**For Emergency Lighting spacing, please see p.5.**

**TECHNICAL SPECIFICATION TABLE**

Lumen package	Watts (W)	Volts (V)	3 000 K		3 500 K		4 000 K		5 000 K		CRI	Life L70 (hrs)	Tested hours LM-80 (hrs)	Power Factor	THD (%)
			Lumen (lm)	Efficacy (lm/W)	Lumen (lm)	Efficacy (lm/W)	Lumen (lm)	Efficacy (lm/W)	Lumen (lm)	Efficacy (lm/W)					
S1B	17	120-277	2 143	126	2 214	130	2 265	133	2 302	135	80+	190 400	9 000	20.2	0.894
S2B	29	347	3 920	131	4 050	135	4 143	138	4 210	141					

**LINK TECHNICAL SPECIFICATION TABLE**

Lumen package	Luminaire Watts (W)	LINK Watts (W)	3 000 K	3 500 K	4 000 K	5 000 K
			Lumen output (lm)	Lumen output (lm)	Lumen output (lm)	Lumen output (lm)
LS1B	18	11	1 273	1 315	1 345	1 367
LS2B	30		1 193	1 232	1 261	1 281

**ACCESSORIES (order separately)**

Part number	Type
HAR06-TPBIT-UDR	Tamper Proof 2" Steel Power Bit

Data is based upon tests performed in a controlled environment. Actual performance can vary depending on operating conditions. All products are subject to change or may be discontinued any time without notice.

**OCCUPANCY SENSORS**
**ON-OFF SENSORS**

Detection - On at (Detection Area) % during (Hold Time) min. Off

Part number	Position	Volts (V)	Technology	Height (ft)	Detection Area (%)	Hold time (min)	Daylight min level (lux)	Remote <sup>1</sup>	Location <sup>2</sup> (°C)
OSE-PO-0301	External	120-347	PIR	20-40	100	20	N/A	N/A	Dry, -10 to +40
OSE-PO-0501	External	120-347	PIR	15-40	100	15	3 000	OSI-FSIR-100	Dry, 0 to +40
OSE-PO-0502	External	120-347	PIR	15-40	100	15	3 000	N/A	Dry, 0 to +40
OSE-PO-0701	External	120-277	PIR	20	100	15	N/A	N/A	Wet, -40 to +40
OSE-PO-0801	External	347	PIR	20	100	15	N/A	N/A	Wet, -40 to +40
OSI-FO-0301	Internal	120-277	High frequency	32 max	100	20	Disable	N/A	Dry and wet, -25 to +40
OSI-FO-0601	Internal	120-347	High frequency	25 max	100	30	Disable	68681	Dry and wet, -35 to +40
OSI-FO-0602	Internal	120-347	High frequency	25 max	100	15	Disable	68681	Dry and wet, -35 to +40
OSI-FO-0603	Internal	120-347	High frequency	25 max	100	15	100	68681	Dry and wet, -35 to +40

C

**BI-LEVEL SENSORS**

Detection - On at (Detection Area) % during (Hold Time) min., then (Stand-by Dim level) %

Part number	Position	Volts (V)	Technology	Height (ft)	Detection Area (%)	Hold time (min)	Stand-by Dim level (%)	Daylight min level (lux)	Remote <sup>1</sup>	Location <sup>2</sup> (°C)
OSE-PB-0202	External	120-347	PIR	20	100	30	40	Disable	OSI-FSIR-100	Wet, -40 to +40
OSI-FB-0301	Internal	120-277	High Frequency	32 max	100	20	30	Disable	N/A	Dry and wet, -25 to +40
OSI-FB-0302	Internal	120-277	High Frequency	32 max	100	20	10	Disable	N/A	Dry and wet, -25 to +40
OSI-FB-0303	Internal	120-277	High Frequency	32 max	100	20	50	Disable	N/A	Dry and wet, -25 to +40
OSE-FB-0402	External	120-347	High Frequency	50 max	100	20	30	50	OSI-RC-MH10	Wet, -35 to +40
OSI-FB-0603	Internal	120-347	High Frequency	25 max	100	15	40	Disable	68681	Dry and wet, -35 to +40
OSI-FB-0604	Internal	120-347	High Frequency	25 max	100	30	40	Disable	68681	Dry and wet, -35 to +40
OSI-FB-0605	Internal	120-347	High Frequency	25 max	100	15	30	Disable	68681	Dry and wet, -35 to +40
OSI-FB-0606	Internal	120-347	High Frequency	25 max	100	15	10	Disable	68681	Dry and wet, -35 to +40

**TRI-LEVEL SENSORS**

Detection - On at (Detection Area) % during (Hold Time) min., then (Stand-by Dim level) % during (Stand-by period) min. Off

Part number	Position	Volts (V)	Technology	Height (ft)	Detection Area (%)	Hold time (min)	Stand-by Dim level (%)	Stand-by period (min)	Daylight min level (lux)	Remote <sup>1</sup>	Location <sup>2</sup> (°C)
OSI-FT-0301	Internal	120-277	High Frequency	32 max	100	20	30	10	Disable	N/A	Dry and wet, -25 to +40
OSE-FT-0402	External	120-347	High Frequency	50 max	100	30	30	10	50	OSI-RC-MH10	Wet, -35 to +40
OSI-FT-0601	Internal	120-347	High Frequency	25 max	100	30	30	10	Disable	68681	Dry and wet, -35 to +40

<sup>1</sup> To be ordered separately.

<sup>2</sup> Min and max ambient temperature of the fixture with the specific sensor. Please verify fixture temperature on the first page for compatibility with sensor.

 For more settings visit  
[www.standardpro.com/documentation/technical-information/](http://www.standardpro.com/documentation/technical-information/)

 Data is based upon tests performed in a controlled environment. Actual performance can vary depending on operating conditions.  
 All products are subject to change or may be discontinued any time without notice.

**MOUNTING OPTIONS**

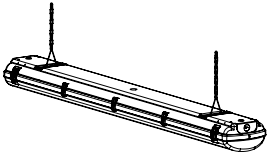
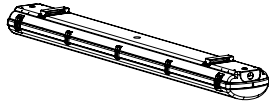
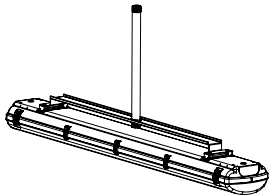
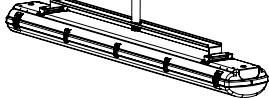
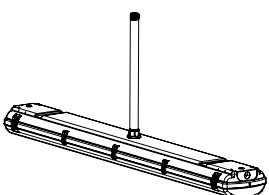
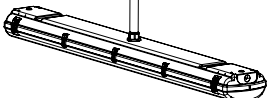
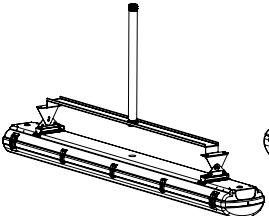
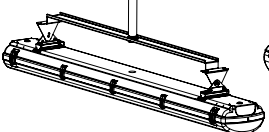
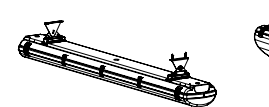
<p><b>SUSPENDED</b></p>	<ul style="list-style-type: none"> <li>– Set of 2 v-hooks for suspended mounting, included with the luminaire</li> <li>– Aviation cable purchased separately, see ordering guide</li> </ul>	
<p><b>SURFACE</b></p>	<ul style="list-style-type: none"> <li>– Stainless steel surface mounting hardware for ceiling / wall, included with the luminaire</li> </ul>	
<p><b>RMB-05</b> Rigid mono point on bracket with 3/4" center hole for 1/2 NPT conduit</p>	<ul style="list-style-type: none"> <li>– To be used in conjunction with the surface mounting hardware, included with the luminaire</li> <li>– For other center hole dimensions, select CH option in the ordering guide</li> </ul>	
<p><b>RMB-075</b> Rigid mono point on bracket with 1" center hole for 3/4 NPT conduit</p>	<ul style="list-style-type: none"> <li>– Conduit not provided</li> </ul>	
<p><b>RMP-05</b> Rigid mono point on the luminaire with 3/4" center hole for 1/2 NPT conduit</p>	<ul style="list-style-type: none"> <li>– Rigid mono point directly on the luminaire with waterproof hub</li> <li>– Conduit not provided</li> </ul>	
<p><b>RMP-075</b> Rigid mono point on the luminaire with 1" center hole for 3/4 NPT conduit</p>		
<p><b>PVPM-05</b> Rigid mono point on pivot mount bracket with 3/4" center hole and 1/2 NPT</p>	<ul style="list-style-type: none"> <li>– To be used in conjunction with the surface mounting hardware, included with the luminaire</li> <li>– For 7/8" center hole, consult CH option on the ordering guide</li> </ul>	
<p><b>PVPM-075</b> Rigid mono point on pivot mount bracket with 1" center hole and 3/4 NPT</p>	<ul style="list-style-type: none"> <li>– Conduit not provided</li> </ul>	
<p><b>PVM</b> Surface mount brackets with pivot (set of 2)</p>	<ul style="list-style-type: none"> <li>– To be used in conjunction with the surface mounting hardware, included with the luminaire</li> <li>– For ceiling / wall surface mounting</li> </ul>	

Note: The fixtures used in diagrams above represents the VT4 series. The diagrams are used to showcase mounting options only.

**DIMENSIONS**

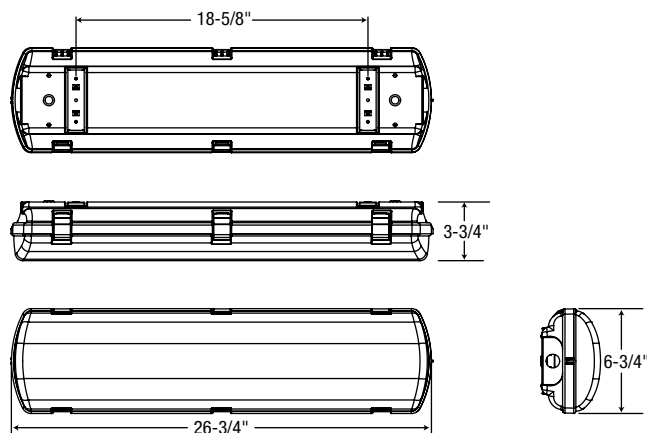

Data is based upon tests performed in a controlled environment. Actual performance can vary depending on operating conditions. All products are subject to change or may be discontinued any time without notice.

# LINK

## NORMALLY ON EMERGENCY REMOTE LUMINAIRE

This luminaire can be used with an emergency backup powered by either a 12 V or 24 V DC Stanpro battery unit, complete with or without auto test.

### NORMAL MODE



### EMERGENCY MODE

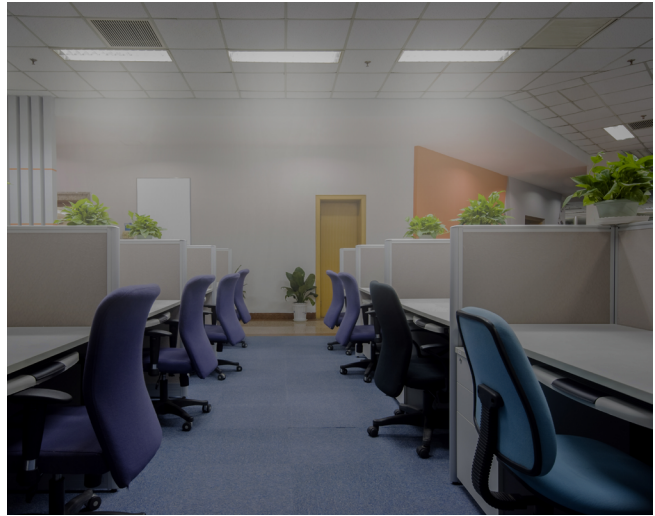

### TYPICAL SPECIFICATION

Supply and install Stanpro LINK \_\_\_\_\_ ft, LED vapor tight, Model number: \_\_\_\_\_ remote normally ON emergency luminaire, CSA C22.2 141-15 certified and meet the requirements prescribed by ICES-005. Normally ON when AC is present and when connected to a Stanpro battery unit complete with or without auto test, the luminaire shall act as an emergency lighting remote and consume 11 W of DC power in \_\_\_\_\_ V producing 2 924 - 3 146 lumens in emergency mode.

The remote normally ON emergency luminaire shall be powered by a Stanpro emergency lighting battery unit as described herein and shown on the drawings. The Stanpro auto diagnostic micro-controller board shall supply the rated load for a minimum of a 1/2 hour to 87.5% of the rated battery voltage. The unit shall be rated 120 V, 277 V or 347 V, 60 Hz and be CSA listed. The unit shall have an output of: \_\_\_V and \_\_\_W. The charge voltage factory set to  $\pm 1\%$  tolerance. High efficiency, rapid recovery, precision control charging system shall be employed to promote long battery life and reduce the potential for grid corrosion. The charger shall provide a continuous high charge to recharge the battery, when the battery is at full capacity, the charger will shut-off. Periodically the charger shall provide a pulse of energy to keep the battery topped off. The pulse charger shall be precisely regulated and shall charge the battery in relation to its temperature, state or charge and input voltage fluctuations. The charger shall be current limited, temperature compensated, short-circuit proof and reverse polarity protected. The unit shall be furnished with an electronic lockout circuit, which will connect the battery when the AC circuit is activated, and an electronic brownout circuit, which will activate the emergency lights when utility power dips below 75% of nominal voltage. A low voltage battery protection circuit shall be provided and will disconnect the load when the battery reaches the end of discharge.

The automated testing performed by the Stanpro auto test system has been designed to comply with all of the requirements of the National Fire Code. Every month, a 5 minute discharge and diagnostic test checks the operational status of the unit. Every 12 months, this test is extended to the full 30 minute, code required duration. This ensures that the battery charger is recharging the battery in accordance with code requirements.

The unit shall be Stanpro model: SL\_ \_\_\_\_\_

Data is based upon tests performed in a controlled environment. Actual performance can vary depending on operating conditions.  
All products are subject to change or may be discontinued any time without notice.

# LINK

## NORMALLY ON EMERGENCY REMOTE LUMINAIRE

### LINK Wiring Diagram

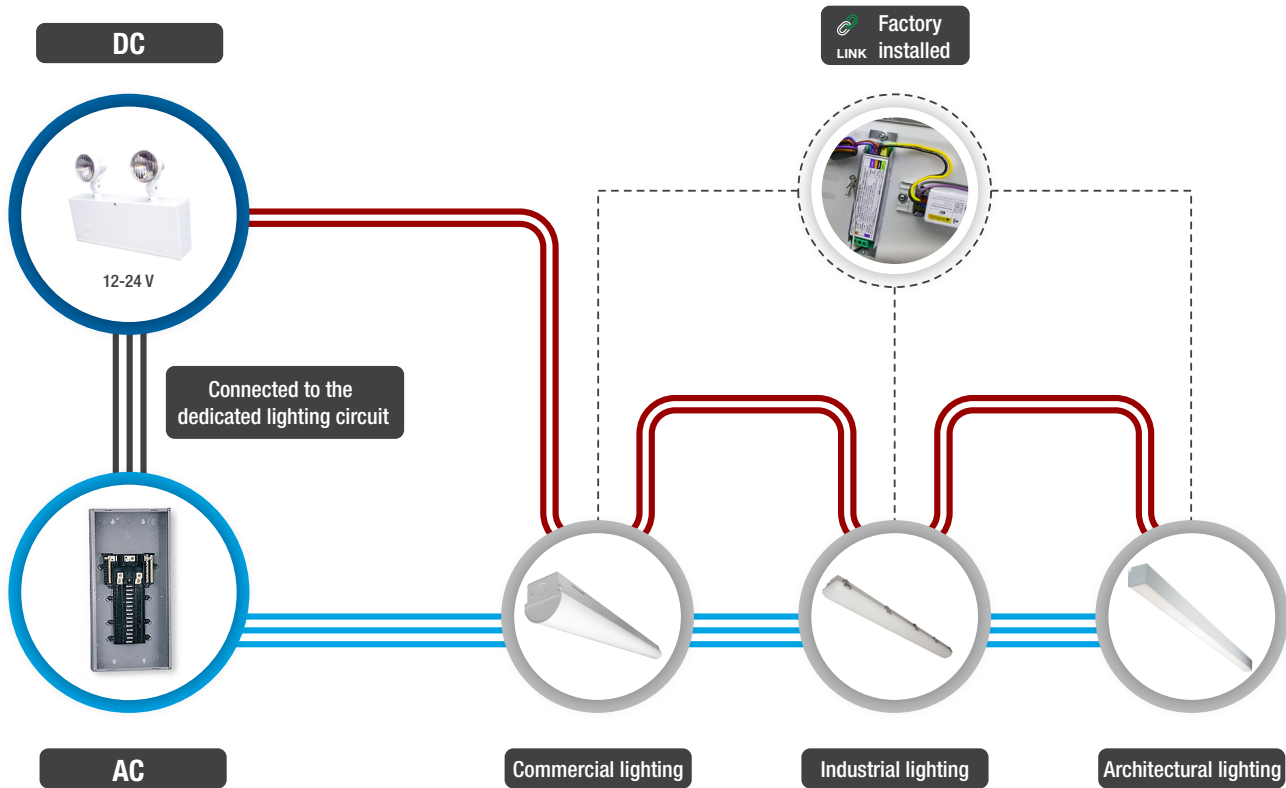

**LEGEND**

- AC wires
- Connected to the dedicated lighting circuit
- DC wires
- LINK factory installed

Emergency mode	Spacing
VT2-L GEN 2	Average spacing for 1 out of every 4 luminaires, normally ON in the path of egress, when at 8, 10, or 12 foot mounting heights.

Data is based upon tests performed in a controlled environment. Actual performance can vary depending on operating conditions. All products are subject to change or may be discontinued any time without notice.

**PHOTOMETRIC DATA<sup>1</sup>**

69430 • VT2-LS1B-80-W/40K • 2 264 lm

**Polar candela distribution**

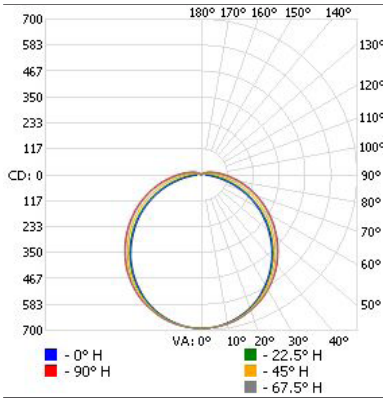

**Zonal lumen summary**

Zone	Lumens	% Fixture
0-30	537.3	23.7
0-40	882.0	39
0-60	1 577.3	69.7
60-90	564.6	24.9
70-100	348.9	15.4
90-120	105.7	4.7
0-90	2 141.8	94.6
90-180	122.3	5.4
0-180	2 264.1	100

**Illuminance at a distance**

Center beam fc		Beam width	
1.7'	239	4.9'	6.1'
3.3'	63.5	9.4'	11.8'
5.0'	27.6	14.3'	17.9'
6.7'	15.4	19.1'	24.0'
8.3'	10.0	23.7'	29.7'
10.0'	6.91	28.6'	35.8'

■ Vert. spread: 110.0°  
■ Horiz. spread: 121.7°

<sup>1</sup> Complete IES files available on our website.

Data is based upon tests performed in a controlled environment. Actual performance can vary depending on operating conditions. All products are subject to change or may be discontinued any time without notice.