

## BOA-L BOLLARD

The BOA-L is an LED bollard luminaire designed with high efficiency. The housing is made of die cast aluminum with a flush mounting base, polycarbonate lens, flat top, and a powdercoat finish over a chromate conversion coating.

### FEATURES AND SPECIFICATIONS

#### • Construction

##### Housing

This luminaire is constructed with aluminum die cast housing in bronze powder coating with anti-corrosive finish.

#### • Electrical

- The drivers allow input from 120-277 V and 347 V is reliable in the coldest of temperatures
- The BOA-L bollard is suitable for ambient temperature range of -40°C to +45°C. Available in 3 000 K, 4 000 K, 5 000 K color temperatures with a lumen per watt ratio of 50 lm/W to 91 lm/W

#### • Compliances

- Wet location
- IP65
- cETLus
- Meets requirements of ICES-005 for class B products

### OVERVIEW

Light source	LED
Watts (W)	25, 35, 50
Lumen output (lm)	1 247 - 4 098
Efficiency (lm/W)	50 - 91
Color temperature (K)	3 000, 4 000, 5 000
CRI	70



**ORDERING GUIDE**

<b>BOA</b>	<b>L</b>						
Series	Lamp type	Lumen package	Volts (V)	Color temp. (K)	Casting color	Style	Options
BOA	L - DEL	S1 - Refer to the lumen chart table for details S2 - Refer to the lumen chart table for details S1 - Refer to the lumen chart table for details S2 - Refer to the lumen chart table for details S3 - Refer to the lumen chart table for details	W - 120-277 H - 347	30K - 3 000 40K - 4 000 50K - 5 000	BR - Bronze SP - Special color	L - Louver  C - Cone	T - Asymmetrical glare shield (180 degree) <sup>1</sup>

<sup>1</sup>The finish is the same as the housing.

Note: The anchor bolt kits are not included with the fixture. Please order separately.

**ACCESSORY (order separately)**

Order code	Description	Type
68462	ANCHOR BOLTS W/TRIANGLE KIT 8IN	Anchor bolt kit

**TECHNICAL SPECIFICATION TABLE**

Lumen package	Style	Volts (V)	LED current (mA)	Watts (W)	3 000 K		4 000 K		5 000 K		CRI	Power factor	THD (%)	B.U.G.
					Lumens	lm/W	Lumens	lm/W	Lumens	lm/W				
S1	Louver	120-277	430 - 230	25	1 247	50	1 347	54	1 341	54	70	0.9	20	B1-U3-G1
		347	430 - 230	25	1 247	50	1 347	54	1 341	54	70	0.9	20	B1-U3-G1
	Cone	120-277	430 - 230	25	1 734	69	1 865	75	1 865	75	70	0.9	20	B1-U3-G1
		347	430 - 230	25	1 734	69	1 865	75	1 865	75	70	0.9	20	B1-U3-G1
S2	Louver	120-277	430 - 230	35	1 915	55	2 082	59	2 082	59	70	0.9	20	B1-U3-G1
		347	430 - 230	35	1 915	55	2 082	59	2 082	59	70	0.9	20	B1-U3-G1
	Cone	120-277	430 - 230	35	2 947	84	3 198	91	3 198	91	70	0.9	20	B1-U3-G1
		347	430 - 230	35	2 947	84	3 198	91	3 198	91	70	0.9	20	B1-U3-G1
S3	Cone	120-277	430 - 230	50	3 811	76	4 098	82	4 098	82	70	0.9	20	B1-U3-G1
		347	430 - 230	50	3 811	76	4 098	82	4 098	82	70	0.9	20	B1-U3-G1

**DIMENSIONS**

Diameter: 8 3/8" (213 mm)

Height: 40 1/2" (1 030 mm)

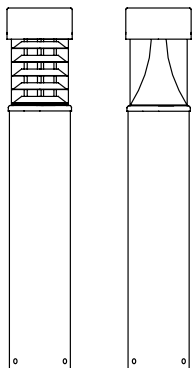

**DRILLING PATTERN**

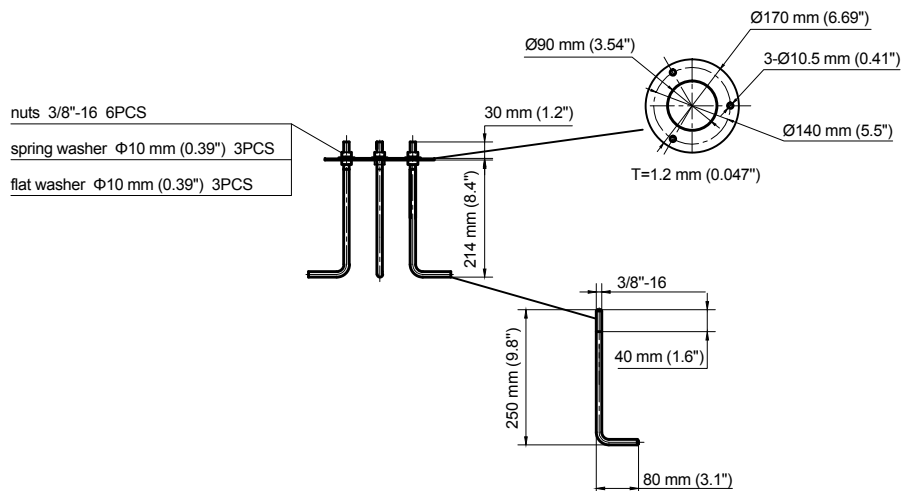

Data is based upon tests performed in a controlled environment. Actual performance can vary depending on operating conditions. All products are subject to change or may be discontinued any time without notice.

**PHOTOMETRIC DATA<sup>1</sup>**

**BOA-LS1-XX-40K-BR-C • 1 865 lm**

**Polar candela distribution**

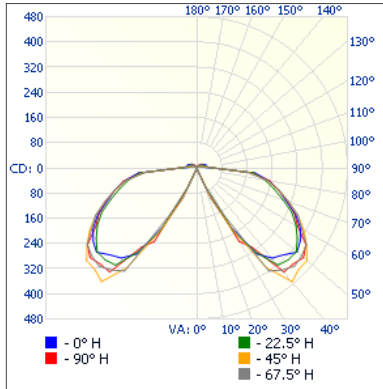

**Zonal lumen summary**

Zone	Lumens	% Fixture
0-30	49.9	2.7%
0-40	266.4	14.3%
0-60	967.2	51.8%
60-90	794.4	42.6%
70-100	492.3	26.4%
90-120	80.8	4.3%
0-90	1 761.6	94.4%
90-180	104.9	5.6%
0-180	1 866.6	100%

**Illuminance at a distance**

Center beam fc	Beam width	
	Vertical	Horizontal
17'	0	20.3' 25.1'
34'	0	40.6' 50.3'
51'	0	60.9' 75.4'
68'	0	81.2' 100.6'
85'	0	101.5' 125.7'
102'	0	121.8' 150.9'

Vert. spread: 61.7°  
Horiz. spread: 73.0°

**BOA-LS1-XX-40K-BR-L • 1 341 lm**

**Polar candela distribution**

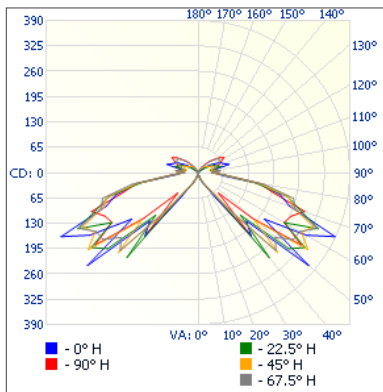

**Zonal lumen summary**

Zone	Lumens	% Fixture
0-30	16.0	1.2%
0-40	72.5	5.4%
0-60	503.6	37.5%
60-90	629.6	46.9%
70-100	374.3	27.9%
90-120	147.4	11%
0-90	1 133.1	84.4%
90-180	209.2	15.6%
0-180	1 342.3	100%

**Illuminance at a distance**

Center beam fc	Beam width	
	Vertical	Horizontal
17'	0	9.6' 64.1'
34'	0	19.2' 128.1'
51'	0	28.9' 192.2'
68'	0	38.5' 256.3'
85'	0	48.1' 320.3'
102'	0	57.7' 384.4'

Vert. spread: 31.6°  
Horiz. spread: 124.1°

**BOA-LS2-XX-40K-BR-C • 3 198 lm**

**Polar candela distribution**

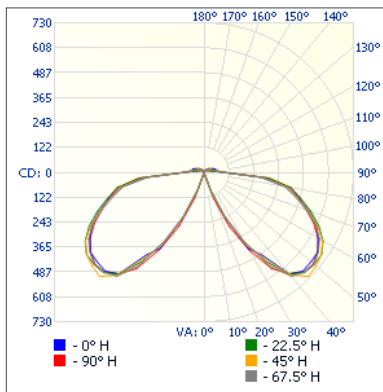

**Zonal lumen summary**

Zone	Lumens	% Fixture
0-30	130.0	4.1%
0-40	467.2	14.6%
0-60	1 613.2	50.4%
60-90	1 402.4	43.8%
70-100	879.7	27.5%
90-120	148.6	4.6%
0-90	3 015.6	94.2%
90-180	185.6	5.8%
0-180	3 201.3	100%

**Illuminance at a distance**

Center beam fc	Beam width	
	Vertical	Horizontal
17'	0	231.1' 222.2'
34'	0	462.1' 444.4'
51'	0	693.2' 666.5'
68'	0	924.2' 888.7'
85'	0	1 155.3' 1 110.9'
102'	0	1 386.4' 1 333.1'

Vert. spread: 163.3°  
Horiz. spread: 162.6°

<sup>1</sup> Complete IES files available on our website.

Data is based upon tests performed in a controlled environment. Actual performance can vary depending on operating conditions. All products are subject to change or may be discontinued any time without notice.

**PHOTOMETRIC DATA<sup>1</sup>**

**BOA-LS2-XX-40K-BR-L • 2 082 lm**

**Polar candela distribution**

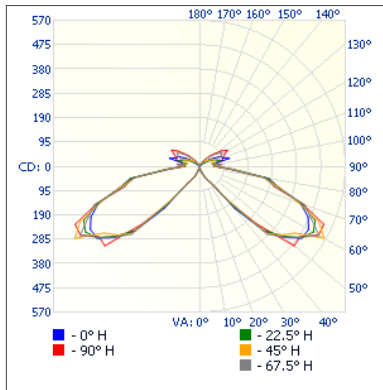

**Zonal lumen summary**

Zone	Lumens	% Fixture
0-30	23.5	1.1%
0-40	88.7	4.3%
0-60	782.3	37.5%
60-90	988.2	47.4%
70-100	576.2	27.7%
90-120	224.0	10.8%
0-90	1 770.5	85%
90-180	313.1	15%
0-180	2 083.7	100%

**Illuminance at a distance**

Center beam fc	Beam width
17'	22.6' 106.9'
34'	45.1' 213.8'
51'	67.7' 320.6'
68'	90.2' 427.5'
85'	112.8' 534.4'
102'	135.3' 641.3'

Vert. spread: 67.1°  
Horiz. spread: 144.7°

**BOA-LS3-XX-40K-BR-C • 4 098 lm**

**Polar candela distribution**

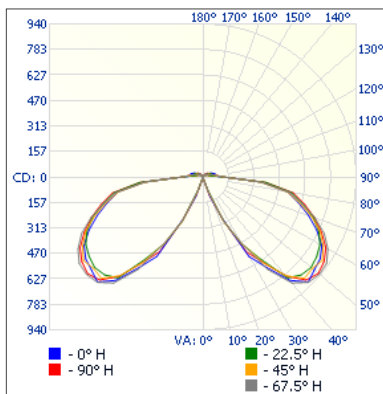

**Zonal lumen summary**

Zone	Lumens	% Fixture
0-30	152.8	3.7%
0-40	567.3	13.8%
0-60	2 035.0	49.6%
60-90	1 828.2	44.6%
70-100	1 139.3	27.8%
90-120	190.3	4.6%
0-90	3 863.2	94.2%
90-180	239.1	5.8%
0-180	4 102.3	100%

**Illuminance at a distance**

Center beam fc	Beam width
17'	165.2' 21.7'
34'	330.5' 43.4'
51'	495.7' 65.1'
68'	661.0' 86.8'
85'	826.2' 108.5'
102'	991.5' 130.2'

Vert. spread: 156.7°  
Horiz. spread: 65.1°

**BOA-LS3-XX-40K-BR-L • 2 667 lm**

**Polar candela distribution**

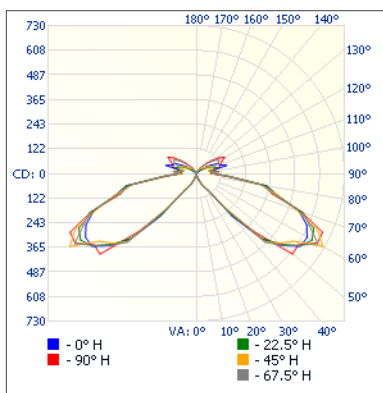

**Zonal lumen summary**

Zone	Lumens	% Fixture
0-30	30.1	1.1%
0-40	113.6	4.3%
0-60	1 002.2	37.5%
60-90	1 265.9	47.4%
70-100	738.1	27.7%
90-120	287.0	10.8%
0-90	2 268.0	85%
90-180	401.1	15%
0-180	2 669.2	100%

**Illuminance at a distance**

Center beam fc	Beam width
17'	22.6' 106.9'
34'	45.1' 213.8'
51'	67.7' 320.6'
68'	90.2' 427.5'
85'	112.8' 534.4'
102'	135.3' 641.3'

Vert. spread: 67.1°  
Horiz. spread: 144.7°

<sup>1</sup> Complete IES files available on our website.

Data is based upon tests performed in a controlled environment. Actual performance can vary depending on operating conditions. All products are subject to change or may be discontinued any time without notice.